

## FWB1451-J

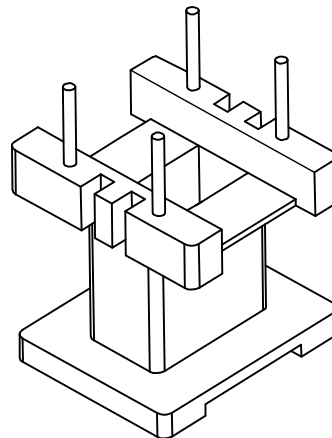
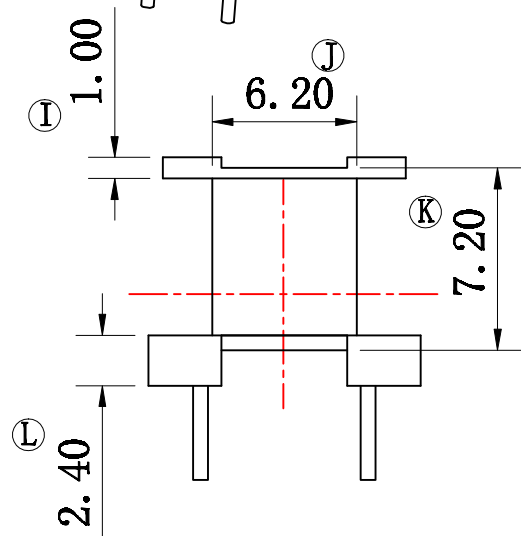
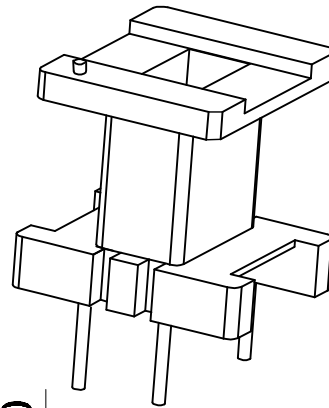
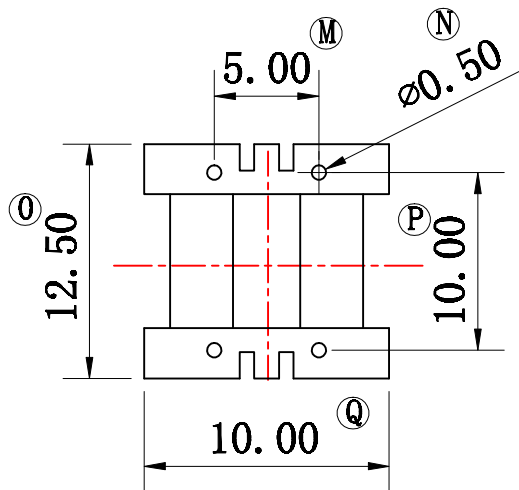
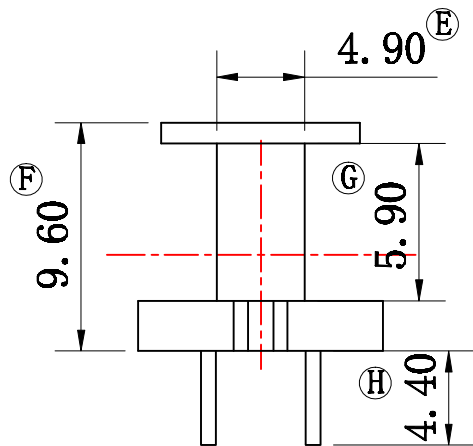
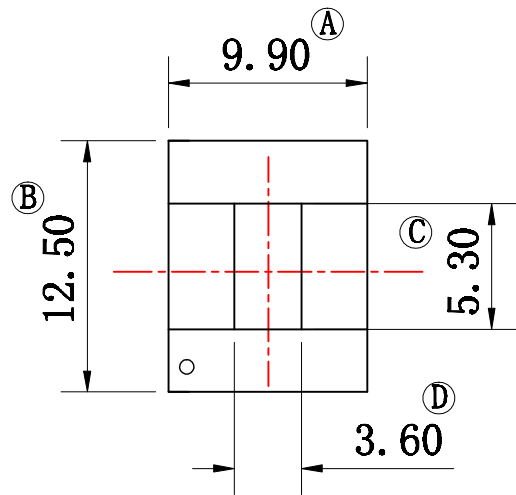

REV	REVISION RECORD	DATE	REV	REVISION RECORD	DATE		
A			C				
B			D				
NAME	EE14 2+2P	MATERIAL	PBT	SCALE	ANGLE	$\pm 1^\circ$	
DRAWING NO.	FWB1451-J	PIN MATERIAL	CP WIRE	UNIT	m/m	REV	A
TOLERANCE OF PIN PITCH $\pm 0.20$				<b>HAINING FERRIWO ELECTRONICS CO.,LTD.</b> TEL: +86-573-87088701 FAX: +86-573-87081130 Web: www.ferriwo.com Email: sales@ferriwo.com			
PIN TENSION LOAD		kg MN	UL REC: 94V-0				
TOLERANCE: $0 < L \leq 4: \pm 0.2$		$4 < L \leq 16: \pm 0.3$	$16 < L \leq 63: \pm 0.4$				